

Before using your air conditioner, please read
this manual carefully and keep it for future reference.

INVERTER SPLIT-TYPE ROOM AIR CONDITIONER

INSTALLATION MANUAL

- Please read this installation manual completely before installing the product.
- If the power cord is damaged, replacement work shall be performed by authorised personnel only.
- Installation work must be performed in accordance with the national wiring Standards by authorised personnel only.
- Contact an authorised service technician for repair, maintenance or installation of this unit.

CONTENTS

SAFETY PRECAUTIONS

Warning	2
Caution	2

INSTALLATION INSTRUCTIONS

Selecting installation place.....	3
Accessories	4
Indoor unit installation.....	5
Outdoor unit installation	7

REFRIGERANT PIPE CONNECTION

Refrigerant pipe connection	8
-----------------------------------	---

ELECTRICAL WORK

Electrical work	9
-----------------------	---

AIR PURGING

Air purging with vacuum pump	12
Safety and leakage check	14

TEST RUNNING

Test running	14
--------------------	----

Read This Manual



Inside you will find many helpful hints on how to install and test the air conditioner properly.

CAUTION

- Contact an authorised service technician for repair or maintenance of this unit.
- Contact an authorised installer for installation of this unit.
- The air conditioner is not intended for use by young children or infirmed persons without supervision.
- Young children should be supervised to ensure that they do not play with the air conditioner.
- If the power cord is to be replaced, replacement work shall be performed by authorised personnel only.
- Installation work must be performed in accordance with the national wiring Standards by authorised personnel only.





SAFETY PRECAUTIONS

- Read the follow SAFETY PRECAUTIONS carefully before installation.
- Electrical work must be installed by a licensed electrician. Be sure to use the correct rating of the power plug and main circuit for the model to be installed.
- Incorrect installation due to ignoring of the instruction will cause harm or damage.
 - **The seriousness is classified by the following indications.**

 WARNING	This symbol indicates the possibility of death or serious injury.
 CAUTION	This symbol indicates the possibility of injury or damage to property.

- **The items to be followed are classified by the symbols:**

	Symbol with background white denotes item that is PROHIBITED from doing.
---	--

 WARNING	
1) Engage dealer or specialist for installation. If installation done by the user is defective, it will cause water leakage, electrical shock fire.	
2) Install according to this installation instructions strictly. If installation is defective, it will cause water leakage, electrical shock fire.	
3) Use the attached accessories parts and specified parts for installation. otherwise, it will cause the set to fall, water leakage, electrical shock fire.	
4) Install at a strong and firm location which is able to withstand the set's weight. If the strength is not enough or installation is not properly done, the set will drop and cause injury.	
5) For electrical work, follow the local national wiring standard, regulation and this installation instructions. An independent circuit and single outlet must be used. If electrical circuit capacity is not enough or defect found in electrical work, it will cause electrical shock fire.	
6) Use the specified cable and connect tightly and clamp the cable so that no external force will be acted on the terminal. If connection or fixing is not perfect, it will cause heat-up or fire at the connection.	
7) Wiring routing must be properly arranged so that control board cover is fixed properly. If control board cover is not fixed perfectly, it will cause heat-up at connection point of terminal, fire or electrical shock.	
8) When carrying out piping connection, take care not to let air substances other than the specified refrigerant go into refrigeration cycle. Otherwise, it will cause lower capacity, abnormal high pressure in the refrigeration cycle, explosion and injury.	
9) Do not modify the length of the power supply cord or use of extension cord, and do not share the single outlet with other electrical appliances. Otherwise, it will cause fire or electrical shock.	
 CAUTION	
1) This equipment must be earthed and installed with earth leakage current breaker. It may cause electrical shock if grounding is not perfect.	
2) Do not install the unit at place where leakage of flammable gas may occur. In case gas leaks and accumulates at surrounding of the unit, it may cause fire.	
3) Carry out drainage piping as mentioned in installation instructions. If drainage is not perfect, water may enter the room and damage the furniture.	

INSTALLATION INSTRUCTIONS

Selecting installation place

Read completely, then follow step by step.

Indoor unit

- Do not expose the indoor unit to heat or steam.
- Select a place where there are no obstacles in front or around the unit.
- Make sure that condensation drainage can be conveniently routed away.
- Do not install near a doorway.
- Ensure that the space on the left and right of the unit is more than 5in.(12cm).
- Use a stud finder to locate studs to prevent unnecessary damage to the wall.
- The indoor unit should be installed on the wall at a height of 6 3/5ft.(2m) or more from the floor.
- The indoor unit should be installed allowing a minimum clearance of 6in.(15cm) from the ceiling.
- Any variations in pipe length will/may require adjustment to refrigerant charge.
- There should not be any direct sunlight. Otherwise, the sun will fade the plastic cabinet and affect its appearance. If unavoidable, sunlight prevention should be taken into consideration.

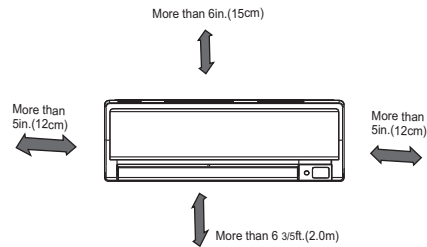

Fig.1

Outdoor unit

- If an awning is built over the outdoor unit to prevent direct sunlight or rain exposure, make sure that heat radiation from the condenser is not restricted.
- Ensure that the clearance around the back of the unit is more than 12in.(30cm) and left side is more than 12in.(30cm). The front of the unit should have more than 79in.(200cm) of clearance and the connection side (right side) should have more than 24in.(60cm) of clearance.
- Do not place animals and plants in the path of the air inlet or outlet.
- Take the air conditioner weight into account and select a place where noise and vibration will not be an issue.
- Select a place so that the warm air and noise from the air conditioner do not disturb neighbors.

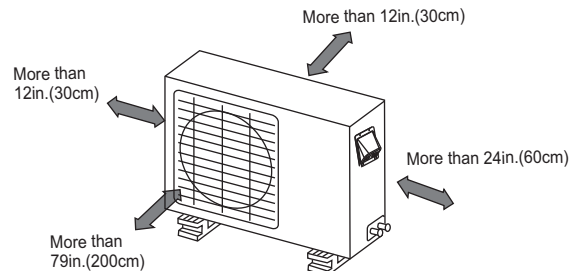

Fig.2

Rooftop installation:

- If the outdoor unit is installed on a roof structure, be sure to level the unit.
- Ensure the roof structure and anchoring method are adequate for the unit location.
- Consult local codes regarding rooftop mounting.
- If the outdoor unit is installed on roof structures or external walls, this may result in excessive noise and vibration, and may also be classed as a non serviceable installation.

Tools needed for installation:

Level gauge
Screwdriver
Electric drill, Hole core drill (ϕ 26in.(65mm))
Flaring tool set
Specified torque wrenches: 1.8kgf.m, 4.2kgf.m,
5.5kgf.m, 6.6kgf.m(different depending on model No.)
Spanner (half union)
Hexagonal wrench (4mm)
Gas-leak detector

Vacuum pump
Gauge manifold
Users manual
Thermometer
Multimeter
Pipe cutter
Measuring tape

INSTALLATION INSTRUCTIONS

Accessories

Number	Name of Accessories		Q'ty	
1	Installation Plate		1	
2	Plastic Expansion Sheath		8	
3	Self-tapping Screw A ST3.9X25		8	
4	Seal (See Page 8 for details)		1	
5	Drain Joint(See page 8 for details)		1	
6	Connecting pipe Assembly	Liquid side	1/4" (<21000Btu/h)	Parts you must purchase (A minimum pipe wall-thickness of 0.7mm is required.)
			3/8" (≥21000Btu/h)	
		Gas side	3/8" (<12000Btu/h)	
			1/2" (≥12000Btu/h)	
			5/8" (≥21000Btu/h)	
7	Remote controller		1	
8	Self-tapping Screw B ST2.9X10		2	
9	Remote controller holder		1	

Note: Except the above parts provided, the other parts needed during installation you must purchase.

CAUTION

- Use a stud finder to locate studs to prevent unnecessary damage to the wall.
- A minimum pipe run of 10ft. (3m) is required to minimise vibration & excessive noise.
- Two of the A, B and C directions should be free from obstructions.

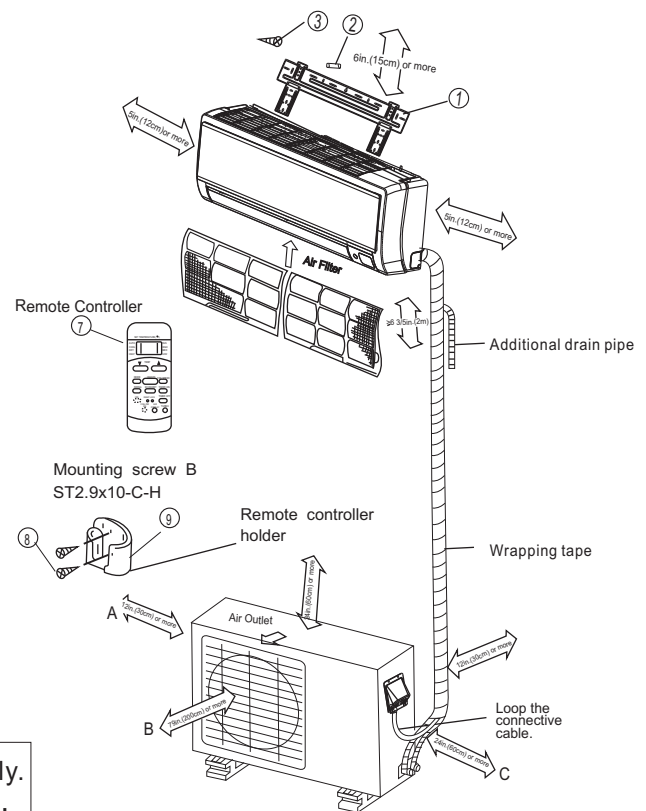

- This illustration is for explanation purposes only.
- Copper lines must be insulated independently.

Fig.3

INSTALLATION INSTRUCTIONS

Indoor unit installation

1. Fit the Installation Plate

1. Fit the installation plate horizontally on structural parts of the wall with spaces around the installation plate.
2. If the wall is made of brick, concrete or the like, drill eight(8) 5mm(0.2in.) diameter holes in the wall. Insert Clip anchor for appropriate mounting screws.
3. Fit the installation plate on the wall with eight(8) type A screws.

Note:

Fit the Installation Plate and drill holes in the wall according to the wall structure and corresponding mounting points on the installation plate.

(Dimensions are in inch unless otherwise stated)

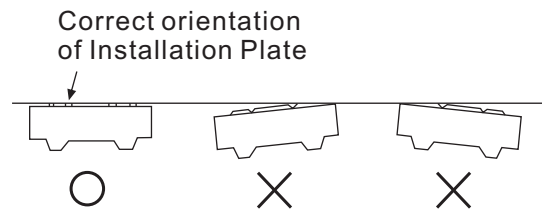

Fig.4

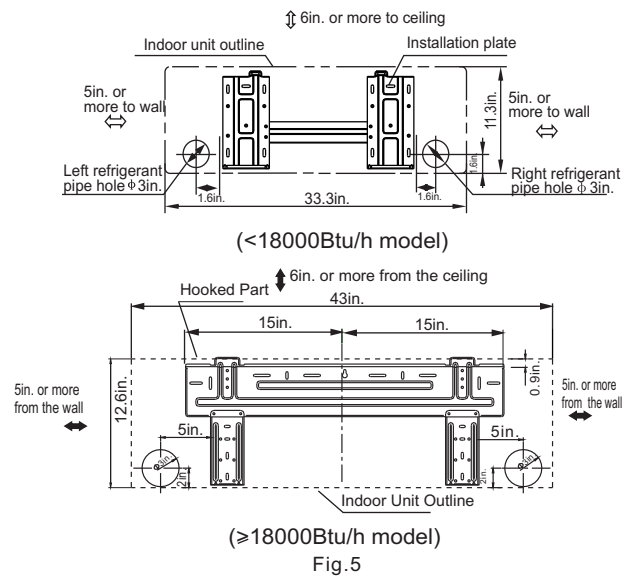

Fig.5

2. Drill a hole in the wall

1. Determine hole positions according to the diagram detailed in Fig.5. Drill one (1) hole ($\phi 3\text{in.}$ (65mm)) slanting slightly to outdoor side.
2. Always use wall hole conduit when drilling metal grid, metal plate or the like.

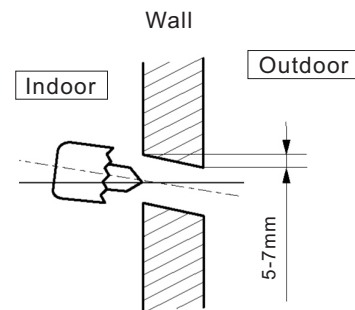

Fig.6

3. Connective Pipe and Drainage Installation

Drainage

1. Run the drain hose sloping downward. Do not install the drain hose as illustrated in Fig.7.

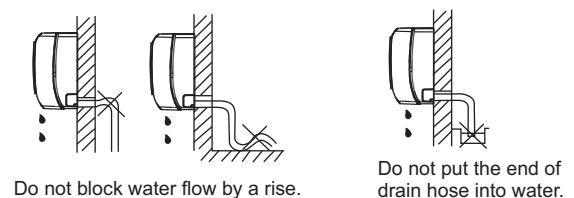

Fig.7

INSTALLATION INSTRUCTIONS

- When connecting extension drain hose, insulate the connecting part of extension drain hose with a shield pipe, do not let the drain hose slack.

Connective pipe installation

- For the left-hand and right-hand piping, remove the pipe cover from the side panel.
- For the rear-right-hand and rear-left-hand piping, install the piping as shown. Bend the connective pipe to be laid at 4in.(43mm) height or less from the wall.
- Fix the end of the connective pipe. (Refer to Tightening Connection in REFRIGERANT PIPING CONNECTION)

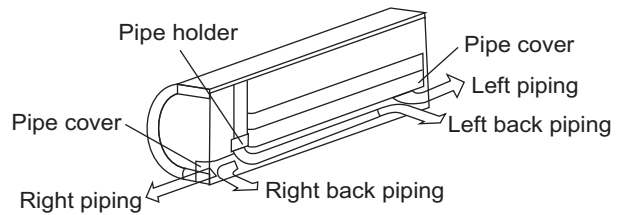

Fig.8

4. Indoor unit installation

- Pass the piping through the hole in the wall.
- Put the upper claw at the back of the indoor unit on the upper hook of the installation plate, move the indoor unit from side to side to see that it is securely hooked (see Fig.10 & Fig.11).
- Piping can easily be made by lifting the indoor unit with a cushioning material between the indoor unit and the wall. Get it out after finish piping.
- Push the lower part of the indoor unit up on the wall, then move the indoor unit from side to side, up and down to check if it is hooked securely.

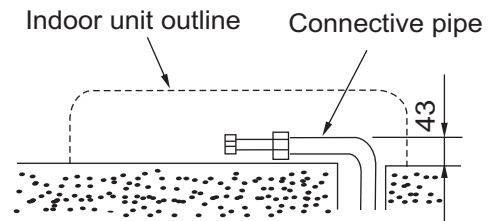

Fig.9

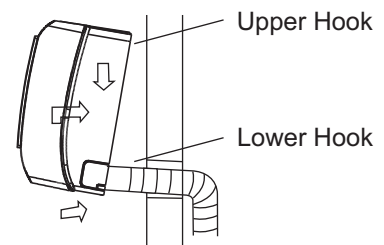

Fig.10

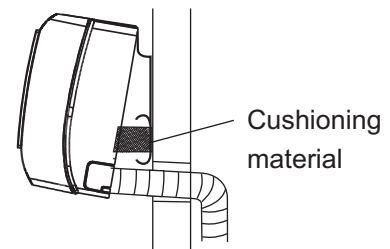

Fig.11

INSTALLATION INSTRUCTIONS

5. Piping and wrapping

Bundle the tubing, connecting cable, and drain hose with tape securely, evenly as shown in Fig.12

- Because the condensed water from rear of the indoor unit is gathered in ponding box and is piped out of room. Do not put anything else in the box.

CAUTION

- Connect the indoor unit first, then the outdoor unit.
- Do not allow the piping to let out from the back of the indoor unit.
- Be careful not to let the drain hose slack.
- Heat insulated both of the auxiliary piping.
- Be sure that the drain hose is located at the lowest side of the bundle. Locating at the upper side can cause drain pan to overflow inside the unit.
- Never intercross nor intertwist the power wire with any other wiring.
- Run the drain hose sloped downward to drain out the condensed water smoothly.

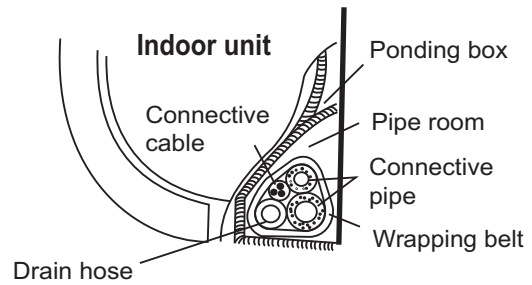

Fig.12

Outdoor unit installation

Outdoor installation precaution

- Install the outdoor unit on a rigid base to prevent increasing noise level and vibration.
- Determine the air outlet direction where the discharged air is not blocked. In the case that the installation place is exposed to strong wind such as a seaside, make sure the fan operating properly by putting the unit lengthwise along the wall or using a dust or shield plates.
- Specially in windy area, install the unit to prevent the admission of wind. If need suspending installation, the installation bracket should accord with technique requirement in the installation bracket diagram.
- The installation wall should be solid brick, concrete or the same intensity construction, or actions to reinforce, damping supporting should be taken. The connection between bracket and wall, bracket and the air conditioner should be firm, stable and reliable.
- Be sure there is no obstacle which block radiating air.

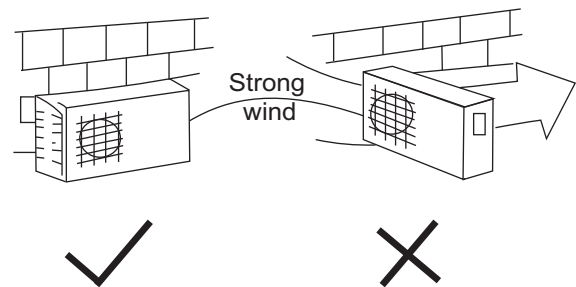

Fig.13

REFRIGERANT PIPE CONNECTION

Settlement of outdoor unit

- Anchor the outdoor unit with a bolt and nut ϕ 10 or ϕ 8 tightly and horizontally on a concrete or rigid mount.

Model (Btu/h)	Outdoor unit dimension (WxHxD)	Mounting dimensions	
		A	B
9000/12000	33" x 23" x 11"	21"	11"
18000	33" x 27" x 13"	22"	13"
24000	35" x 34" x 13"	23"	13"

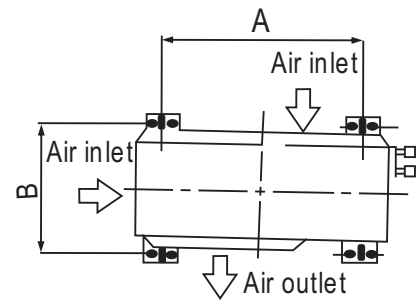

Fig.14

Drain joint installation

Fit the seal into the drain elbow, then insert the drain joint into the base pan hole of outdoor unit, rotate 90° to securely assemble them.

Connecting the drain joint with an extension drain hose (Locally purchased), in case of the water draining off the outdoor unit during the heating mode.

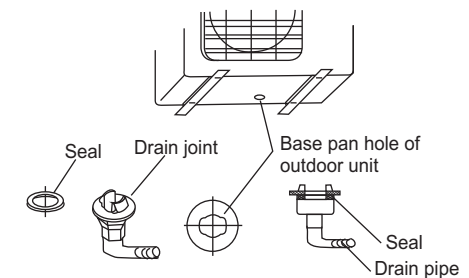

Fig.15

Refrigerant pipe connection

1. Flaring work

Main cause for refrigerant leakage is due to defect in the flaring work. Carry out correct flaring work using the following procedure:

A: Cut the pipes and the cable.

- Use the piping kit accessory or pipes purchased locally.
- Measure the distance between the indoor and the outdoor unit.
- Cut the pipes a little longer than the measured distance.
- Cut the cable 5ft.(1.5m) longer than the pipe length.

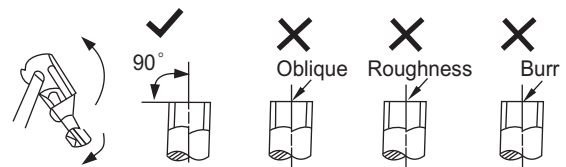

Fig.16

B: Burr removal

- Completely remove all burrs from the cut cross section of pipe/tube.
- Put the end of the copper tube/pipe in a downward direction as you remove burrs in order to avoid dropping burrs into the tubing.

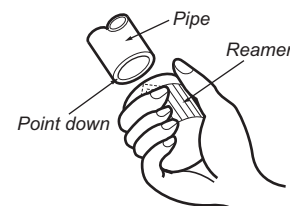

Fig.17

C: Putting nut on

Remove flare nuts attached to indoor and outdoor unit, then put them on pipe/tube having completed burr removal. (not possible to put them on after flaring work)

D: Flaring work

Firmly hold copper pipe in a die in the dimension shown in the table below.

Outer diam.	A(mm)	
	Max.	Min.
1/4"	1.3	0.7
3/8"	1.6	1.0
1/2"	1.8	1.0
5/8"	2.4	2.2

Tightening Connection

- Align the center of the pipes.
- Sufficiently tighten the flare nut with fingers, and then tighten it with a spanner and torque wrench as shown in Fig.20 & 21.

Outer diam.	Tightening torque(N.cm)	Additional tightening torque(N.cm)
1/4"	1570 (160kgf.cm)	1960 (200kgf.cm)
3/8"	2940 (300kgf.cm)	3430 (350kgf.cm)
1/2"	4900 (500kgf.cm)	5390 (550kgf.cm)
5/8"	7360 (750kgf.cm)	7850 (800kgf.cm)

Caution

- Excessive torque can break nut depending on installation conditions.

Electrical work

Electric safety regulations for the initial Installation

1. If there is serious safety problem about the power supply, the technicians should refuse to install the air conditioner and explain to the client until the problem is solved.
2. Power voltage should be in the range of 90%~110%of rated voltage.
3. The creepage protector and main power switch with a 1.5 times capacity of Max. Current of the unit should be installed in power circuit.
4. Ensure the air conditioner is grounded well.
5. According to the attached Electrical Connection Diagram located on the panel of the outdoor unit to connect the wire.
6. All wiring must comply with local and national electrical codes and be installed by qualified and skilled electricians.
7. An individual branch circuit and single receptacle used only for this air conditioner must be available. See the following table for suggested wire sizes and fuse specifications:

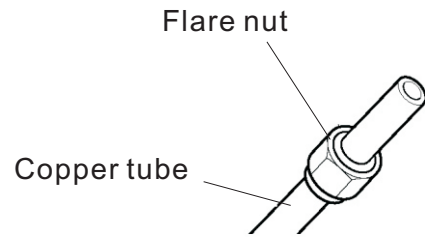

Fig.18

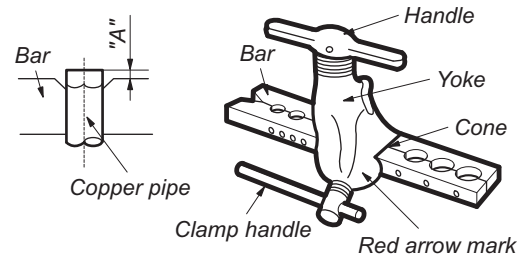

Fig.19

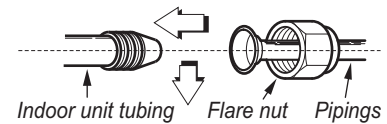

Fig.20

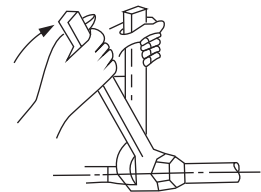

Fig.21

ELECTRICAL WORK

Power supply	Input Rated Amp (Switch/Fuse)
208-230V~60Hz	30A/25A (<12000Btu/h)
	40A/30A (≥12000Btu/h)

NOTE: The supply voltage must be consistent with the rate voltage of the air conditioner.

Minimum nominal cross-sectional area of conductors:

Rated current of appliance (A)	Nominal cross-sectional area (mm ²)
>3 and ≤6	0.75
>6 and ≤10	1
>10 and ≤16	1.5
>16 and ≤25	2.5

Connect the cable to the indoor unit

NOTE: Before performing any electrical work, turn off the main power to the system.

1. The inside and outside connecting cable can be connected without removing the front grille.
2. Connecting cable between indoor unit and outdoor unit shall be approved polychloroprene sheathed flexible cord, type designation H07RN-F or heavier cord.
3. Lift the indoor unit panel up, remove the electrical box cover by loosening the screw as shown in Fig.22.
4. Ensure the colour of wires of outdoor unit and the terminal Nos. are the same to the indoor's respectively.
5. Wrap those cables not connected with terminals with insulation tapes, so that they will not touch any electrical components. Secure the cable onto the control board with the cord clamp.

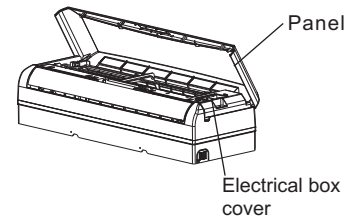

Terminal block of indoor unit

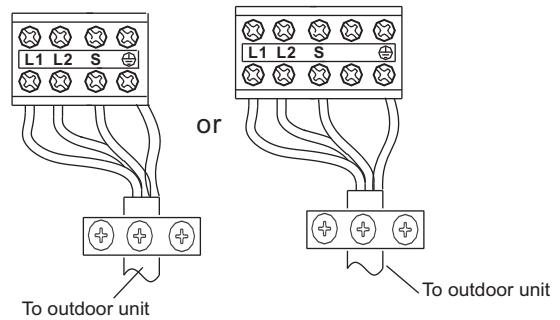

Fig.22

Connect the cable to the outdoor unit

1. Remove the cover control from the unit by loosening the 3 screws. See Fig.23.
2. Dismount caps on the conduit panel.
3. Temporarily mount the conduit tubes(not included) on the conduit panel.
4. Properly connect both the power supply and low voltage lines to the corresponding terminals on the terminal block.
5. Ground the unit in accordance with local codes.
6. Be sure to size each wire allowing several inches longer than the required length for wiring.
7. Use lock nuts to secure the conduit tubes.

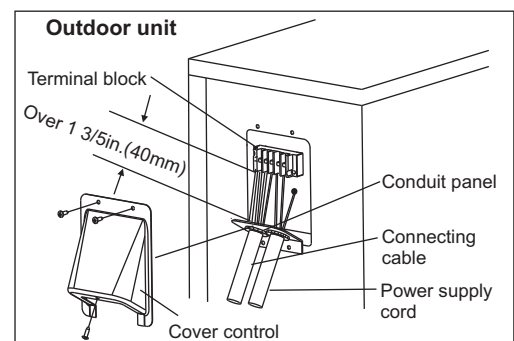
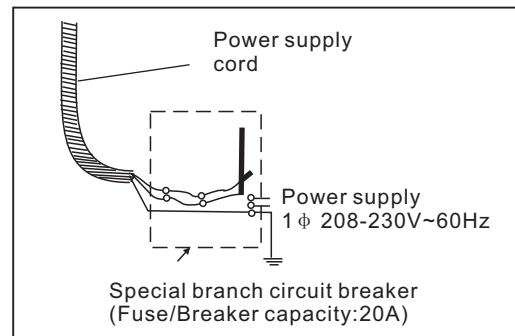

Fig.23a

ELECTRICAL WORK

Warning

- Be sure to comply with local codes while running the wire from the indoor unit to the outdoor unit.
- Every wire must be connected firmly.
- No wire should be allowed to touch refrigerant tubing, the compressor or any moving parts.
- Loose wiring may cause the terminal to overheat or result in unit malfunction.
- A fire hazard may also exist. Therefore, be sure all wiring is tightly connected.
- Disconnecting means must be provided and shall be located within sight from and readily accessible from the air conditioner.
- Connecting cable with conduit shall go through the hole of the conduit panel.



Note : To prevent wires loosening or leaving the Cord Clamp, please select proper cord diameter to fill the holes on the cord clamp.

Terminal block of outdoor unit

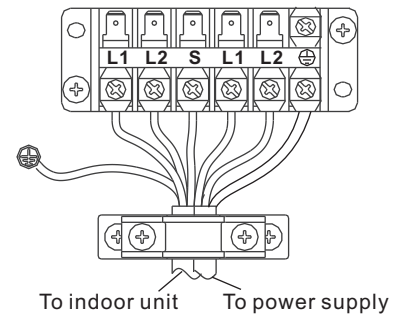

(1)

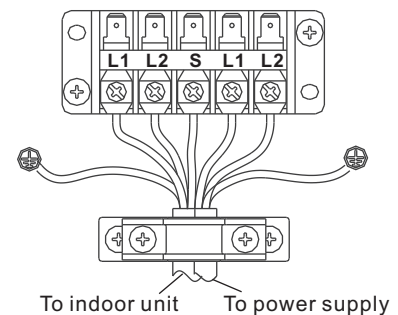

(2)

Fig.23b

AIR PURGING

CAUTION

After the confirmation of the above conditions, prepare the wiring as follows:

- 1) **Never fail to have an individual power circuit specifically for the air conditioner. As for the method of wiring, be guided by the circuit diagram posted on the inside of control cover.**
- 2) **The screw which fasten the wiring in the casing of electrical fittings are liable to come loose from vibrations to which the unit is subjected during the course of transportation. Check them and make sure that they are all tightly fastened. (If they are loose, it could cause burn-out of the wires.)**
- 3) **Specification of power source.**
- 4) **Confirm that electrical capacity is sufficient.**
- 5) **See to that the starting voltage is maintained at more than 90 percent of the rated voltage marked on the name plate.**
- 6) **Confirm that the cable thickness is as specified in the power source specification.**
- 7) **Always install an earth leakage circuit breaker in a wet or moist area.**
- 8) **The following would be caused by voltage drop.**

Vibration of a magnetic switch, which will damage the contact point, fuse breaking, disturbance of the normal function of the overload.

- 9) **The means for disconnection from a power supply shall be incorporated in the fixed wiring and have an air gap contact separation of at least 3mm in each active(phase) conductors.**

Air purging

Air and moisture in the refrigerant system have undesirable effects as indicated below:

- Pressure in the system rises.
- Operating current rises.
- Cooling or heating efficiency drops.
- Moisture in the refrigerant circuit may freeze and block capillary tubing.
- Water may lead to corrosion of parts in the refrigeration system.

Therefore, the indoor unit and tubing between the indoor and outdoor unit must be leak tested and evacuated to remove any noncondensables and moisture from the system.

Air purging with vacuum pump

- Preparation
Check that each tube(both liquid and gas side tubes) between the indoor and outdoor units have been properly connected and all wiring for the test run has been completed. Remove the service valve caps from both the gas and the liquid side on the outdoor unit. Note that both the liquid and the gas side service valves on the outdoor unit are kept closed at this stage.
- Pipe length and refrigerant amount:

Connective pipe length	Air purging method	Additional amount of refrigerant to be charged	
Less than 16 2/5ft.(5m)	Use vacuum pump.	_____	
More than 16 2/5ft.(5m)	Use vacuum pump.	1/4" (Liquid side) R410A: (Pipe length-5)x20g/m	3/8" (Liquid side) R410A: (Pipe length-5)x40g/m

- When relocate the unit to another place, perform evacuation using vacuum pump.
- Make sure the refrigerant added into the air conditioner is liquid form in any case.
(Not applicable to the units adopt freon R22)

Caution in handling the packed valve

- Open the valve stem until it hits against the stopper. Do not try to open it further.
- Securely tighten the valve stem cap with a spanner or the like.
- Valve stem cap tightening torque (See Tightening torque table in previous page).

When Using the Vacuum Pump

(For method of using a manifold valve, refer to its operation manual.)

1. Completely tighten the flare nuts, A, B, C, D, connect the manifold valve charge hose to a charge port of the low-pressure valve on the gas pipe side.
2. Connect the charge hose connection to the vacuum pump.
3. Fully open the handle Lo of the manifold valve.
4. Operate the vacuum pump to evacuate. After starting evacuation, slightly loose the flare nut of the Lo valve on the gas pipe side and check that the air is entering (Operation noise of the vacuum pump changes and a compound meter indicates 0 instead of minus)
5. After the evacuation is complete, fully close the handle Lo of the manifold valve and stop the operation of the vacuum pump. Make evacuation for 15 minutes or more and check that the compound meter indicates -76cmHg ($-1 \times 10^5 \text{Pa}$).
6. Turn the stem of the packed valve B about 45° counterclockwise for 6~7 seconds after the gas coming out, then tighten the flare nut again. Make sure the pressure display in the pressure indicator is a little higher than the atmosphere pressure.
7. Remove the charge hose from the Low pressure charge hose.
8. Fully open the packed valve stems B and A.
9. Securely tighten the cap of the packed valve.

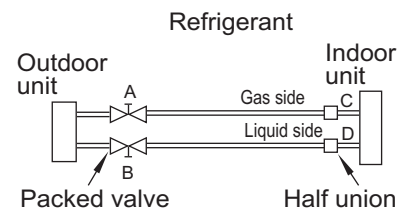

Fig.24

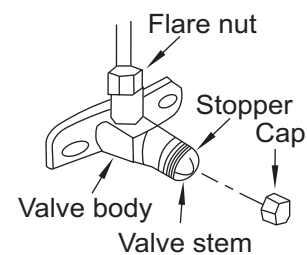

Fig.25

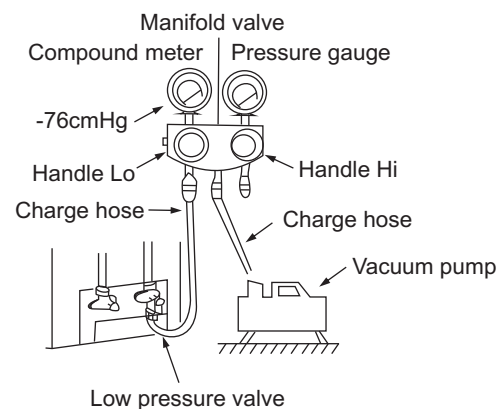

Fig.26

TEST RUNNING

Safety and leakage check

● Electrical safety check

Perform the electric safe check after completing installation:

1. Insulated resistance

The insulated resistance must be more than $2M\Omega$.

2. Grounding work

After finishing grounding work, measure the grounding resistance by visual detection and grounding resistance tester. Make sure the grounding resistance is less than 4Ω .

3. Electrical leakage check (performing during test running)

During test operation after finishing installation, the serviceman can use the electroprobe and multimeter to perform the electrical leakage check. Turn off the unit immediately if leakage happens. Check and find out the solution ways till the unit operate properly.

● Gas leak check

1. Soap water method:

Apply a soap water or a liquid neutral detergent on the indoor unit connection or outdoor unit connections by a soft brush to check for leakage of the connecting points of the piping. If bubbles come out, the pipes have leakage.

2. Leak detector

Use the leak detector to check for leakage.

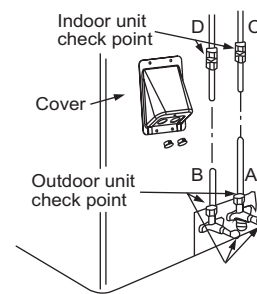

Fig.27

CAUTION

A: Lo packed valve B: Hi packed valve

C and D are ends of indoor unit connection.

Test running

Perform test operation after completing gas leak check at the flare nut connections and electrical safety check.

- Check that all tubing and wiring have been properly connected.
 - Check that the gas and liquid side service valves are fully open.
1. Connect the power, press the ON/OFF button on the remote controller to turn the unit on.
 2. Use the MODE button to select COOL, HEAT, AUTO and FAN to check if all the functions works well.
 3. When the ambient temperature is too low (lower than 62°F), the unit cannot be controlled by the remote controller to run at cooling mode, manual operation can be taken. Manual operation is used only when the remote controller is disable or maintenance necessary.
 - Hold the panel sides and lift the panel up to an angle until it remains fixed with a clicking sound.
 - Press the Manual control button to select the AUTO or COOL, the unit will operate under Forced AUTO or COOL mode (see User Manual for details).
 4. The test operation should last about 30 minutes.

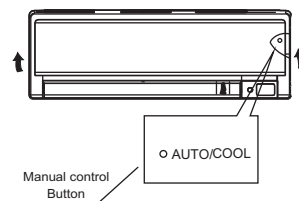

CS014I-BPV1
202000100314